

# HD IP CAMERA USER GUIDE

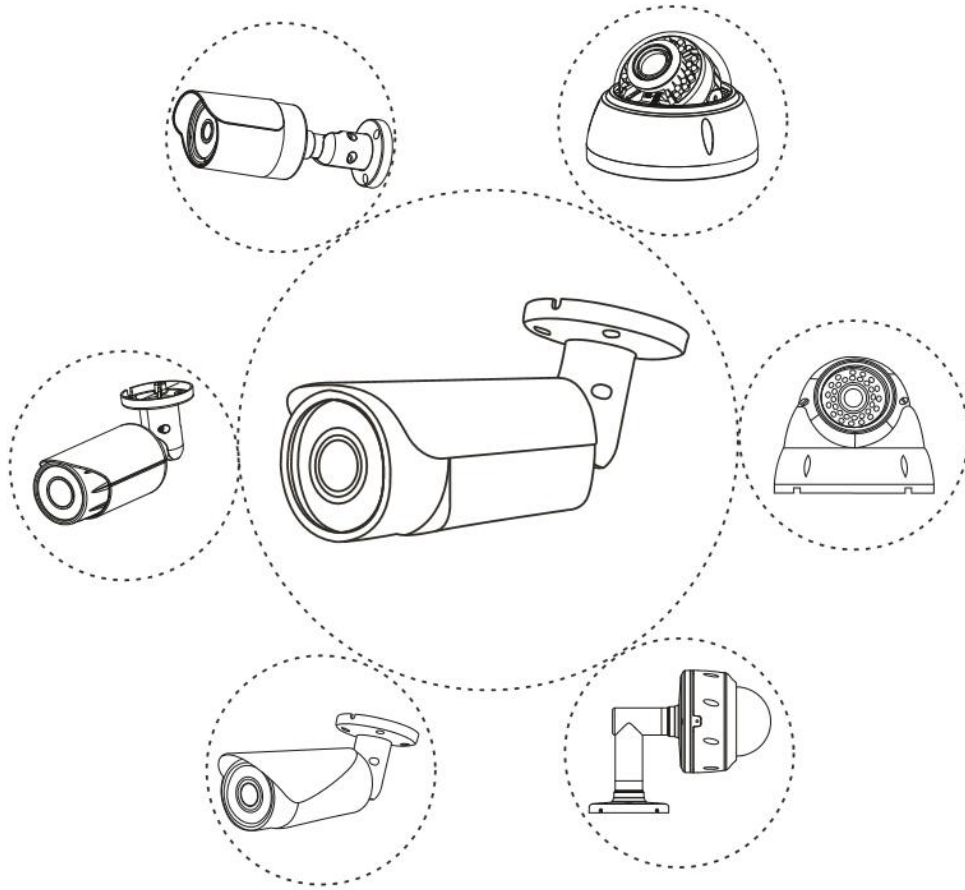

N Series: V2.0

*Note: This manual may contain some incorrect information, even though it was published with our carefully proofreading. The new updates will be added to the next release without notice. Your valuable advice is really appreciated.*

# Table of contents

Connecting the camera to system ( <i>reference only</i> ).....	3
Camera's IP address assignment.....	4
Obtaining IP settings automatically by DHCP.....	4
Assigning Static IP Address by tool.....	4
How to find out the LAN configuration via Windows GUI ?.....	5
Working with Internet Explorer web browser.....	5
Install web plugin or choose plug-free.....	6
Live preview.....	6
Configurations.....	8
1) To setup the camera Time & Date.....	8
2) To name the camera title.....	9
3) Image Setup.....	10
4) SD memory card recording(optional).....	11
5) Playback and Download video (optional).....	11
6) Smart phone p2p remote access by scanning QR code.....	12
7) To setup Smart Human Detection and Vehicle Detection (default enabled). 13	
8) * To setup Smart Line Crossing Detection.....	14
9) * To setup Smart Perimeter protection.....	14
10) * To setup Smart Face Detection.....	16
Working with smart Phone (Android & iPhone).....	17
Function description.....	18
Working with NVR.....	21
Frequently Asked Questions.....	22
1. Why can't I open the default IP address 192.168.0.123 via web browser? ...	22
2. How to reset the password?.....	22
3. How to upgrade the IP camera?.....	22
4. How to fetch the RTSP video stream and http snapshot?.....	22
5. How to Add IP camera to NVR?.....	22
6. How to make the NVR record in motion detection mode?.....	22
7. Where can i control the motorized auto focus lens zoom?.....	22
8. Which kinds of third-party security software can be compatible with?.....	22

## Connecting the camera to system (reference only)

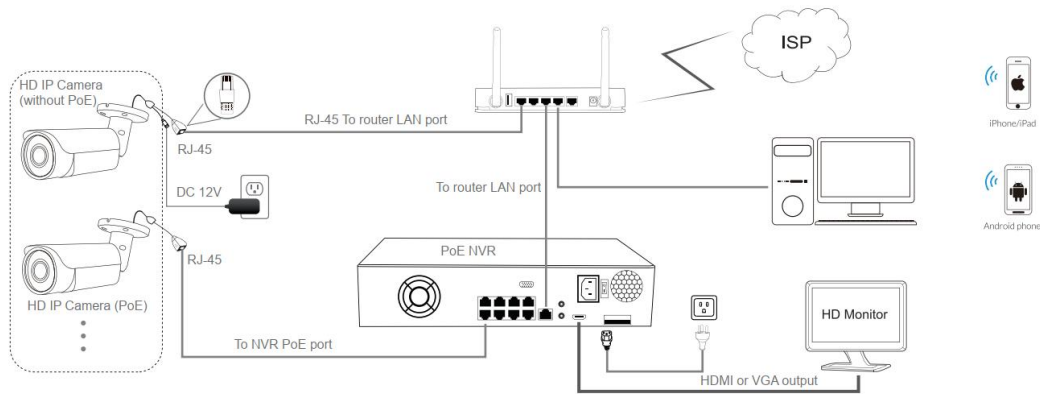

Figure 1: Working With PoE NVR

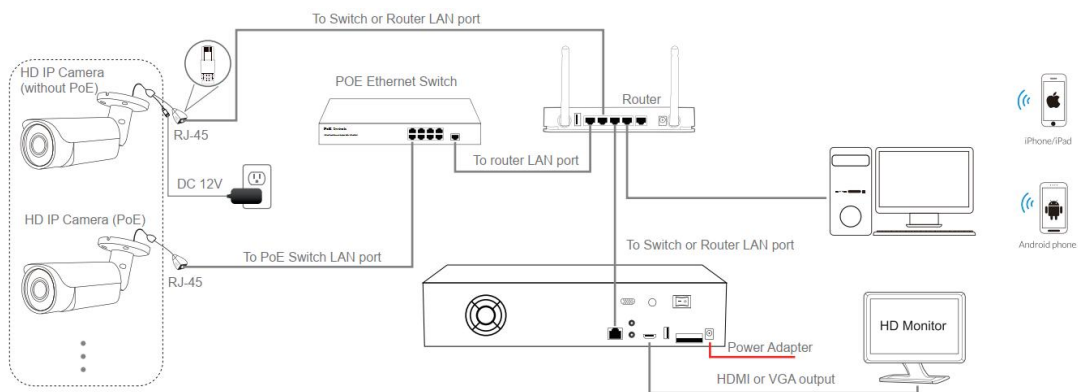

Figure 2: Working With PoE switch and NVR

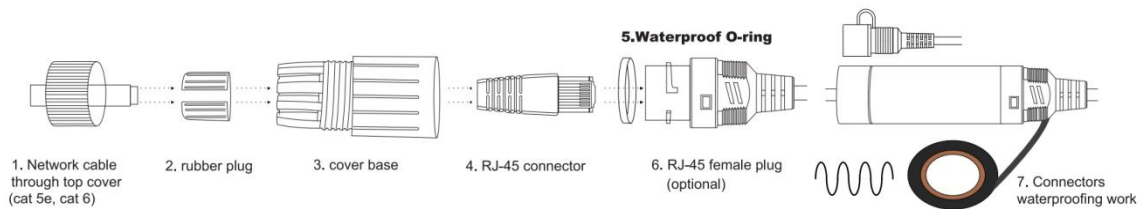

Figure 3: Waterproofing work (network connector)

### Note:

1. The camera should be connected to an OPTIONAL 12 volt power supply if you do not use PoE (Power over Ethernet).
2. A Windows computer is more convenient to setup and troubleshooting.
3. It is very important that network connector waterproofing work should be more carefully on the outdoor operating.

# Camera's IP address assignment

**Default IP address:** 192.168.0.123 (DHCP)

**Username:** admin, **Password:** 123456

*( We strongly recommend modifying the default password for your security).*

## Obtaining IP settings automatically by DHCP

This series camera default network configuration is **DHCP** mode, you can get IP settings assigned automatically from the LAN router or DHCP server, otherwise, the camera will set its own IP address to **192.168.0.123** in a few seconds for local access. The camera will save the obtained IP settings to **static** configuration after 24 hours continues running to keep your system working more stable.

## Assigning Static IP Address by tool

You can install the **device search tool** to quickly configure the IP camera.

- Using Device Search Tool (SettingTool)



The screenshot shows the SettingTool V3.0.0.47\_20240808 interface. At the top, there are tabs for "Search", "Configure", and "Export". Below these is a table with columns: Index, IP, HTTP port, Model, Software version, Status, MAC, and SN. Two rows are visible, both with IP 192.168.0.123 and status "Login failed!".

An "IP Config" dialog box is open in the center. It has a "DHCP" checkbox (labeled 4) which is unchecked. Below it are input fields for "Start IP" (192.168.0.123), "End IP" (192.168.0.124), "Subnet" (255.255.255.0), "Gateway" (192.168.0.1), "DNS1" (8.8.8.8), and "DNS2" (8.8.8.8). A "Check" button (labeled 5) is next to the Start IP field. Below the input fields, a message says "No IP conflicts found!" with a red arrow pointing to it. At the bottom of the dialog is a "Save" button (labeled 6).

At the bottom of the main window, there is a control bar. On the left, there is a "Start Search" button (labeled 1) and a "Config IP" button (labeled 3). Other buttons include "Add", "Clean", "admin", "Video", "Batch Reset", "Batch Reboot", "All Subnet", "Upgrade Firmware", "Browse...", "Batch Set Passwd", and "Talk".

Click **Start Search** and all your cameras in the LAN will be listed in seconds.

If you prefer to assign camera IP address manually, you'd better confirm the IP network planning and avoid IP address conflict.

It is user-friendly that the search tool can calculate the selected cameras number to match the range of Start IP and End IP.

### Tips:

1. **Net Card:** Only select the desired network adapter to search
2. **Batch Reset:** Restore to factory default settings;
3. **Video Preview:** Double-click list items;
4. **Go to Web:** right-click list item and select web;
5. **Upgrade Firmware:** Select the check-box, click **Browse** then click **Upgrade Firmware**.

### How to find out the LAN configuration via Windows GUI ?

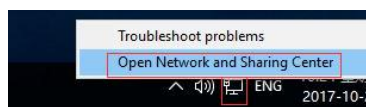

Right-click on the Network icon and select **open Network and Sharing Center**.

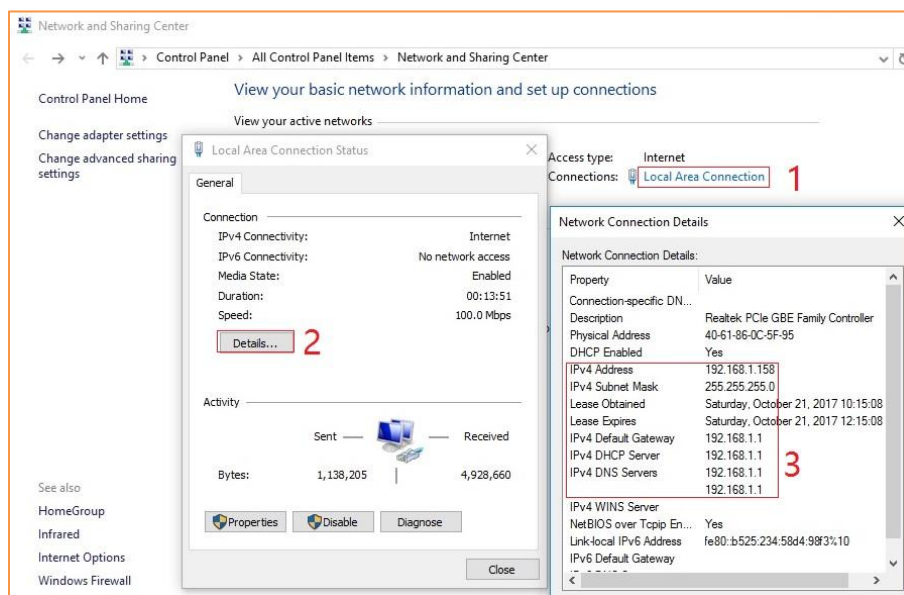

### Working with Internet Explorer web browser

To access the camera's web interface, type in the IP camera's IP address in Internet Explorer's URL bar to gain access to the login page.

Please check your current network connection or modify IP address to the same subnet if login page can not load.

(Default user name: **admin**, Password: **123456**)

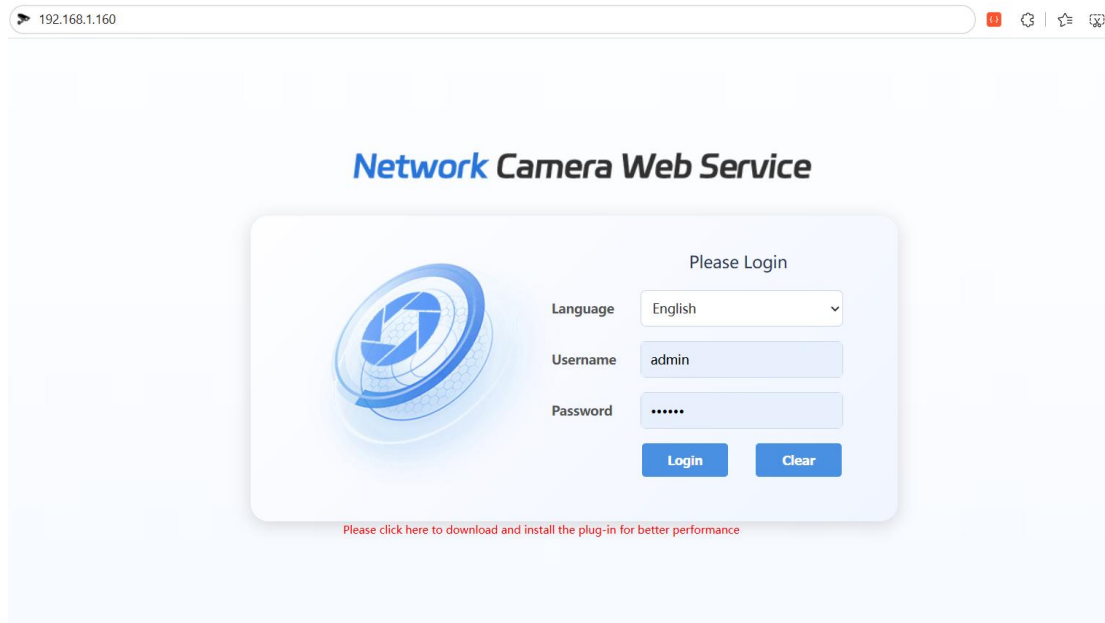

## Install web plugin or choose plug-free

You can use Chrome , Edge, Firefox ,safari to access the camera web service page. (Windows OS perfect supported with plug-in, other OS just can use HTML5 plug-in free)

At the first time login, the web browser will prompt plug-in link to download for video player. Please download and install it without worry about the security.

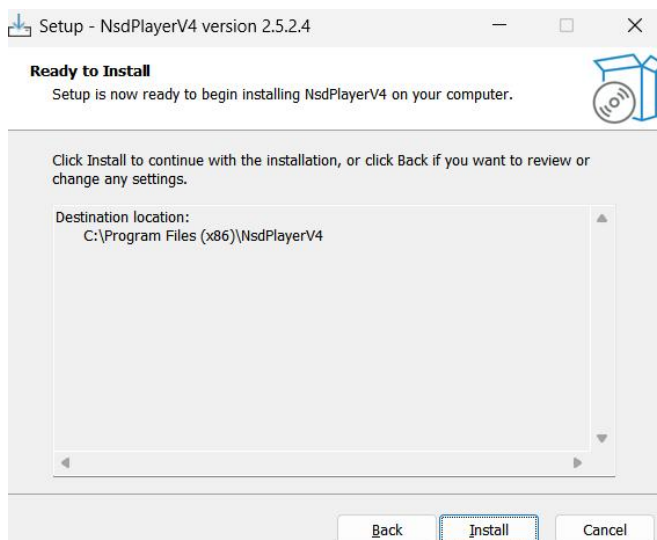

After restart or refresh your web browser and allow the plug-in player to run. The live video will start playing automatically after login successfully.

**Note:** if the plugin installation process pop up error, please make sure all the web browser is closed then try again.

(open the PC **Task manager**, kill all the web browser tasks like "Edge, chrome")

## Live preview

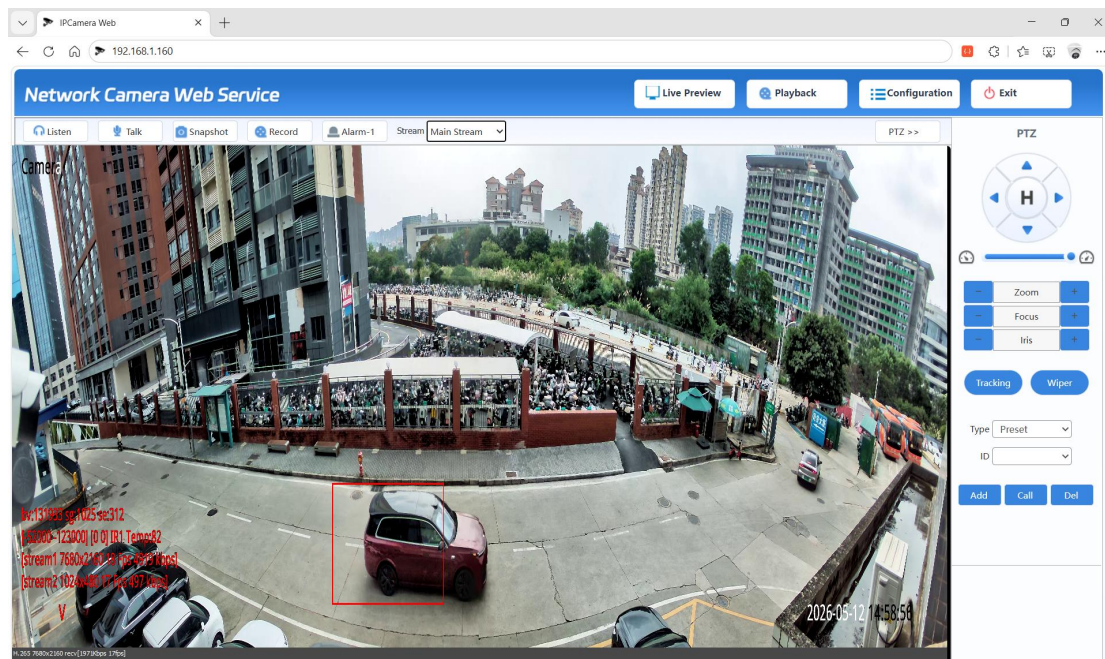

**Listen:** open then camera audio

**Talk:** open two-way audio intercom

**Snapshot:** capture the current image

**Record:** record the current video stream

**Alarm-1:** manually trigger the alarm-in

**Stream:** switch the HD and SD stream

**PTZ:** open or close the right PTZ control slider

**Note:**

1. Windows OS is perfect supported , other OS may lack of some functions play less smoothly because of the HTML5 decoding efficiency.

2. Only the **Motorized Auto Focus** or **PTZ** cameras can do optical **Zoom In** and **Zoom Out** in PTZ button page.

3. Keeping pressing on live video and dragging for **Digital Zoom**. (Windows only)

4. If there is a delay in video response when accessing remotely, please switch to Sub Stream instead.

# Configurations

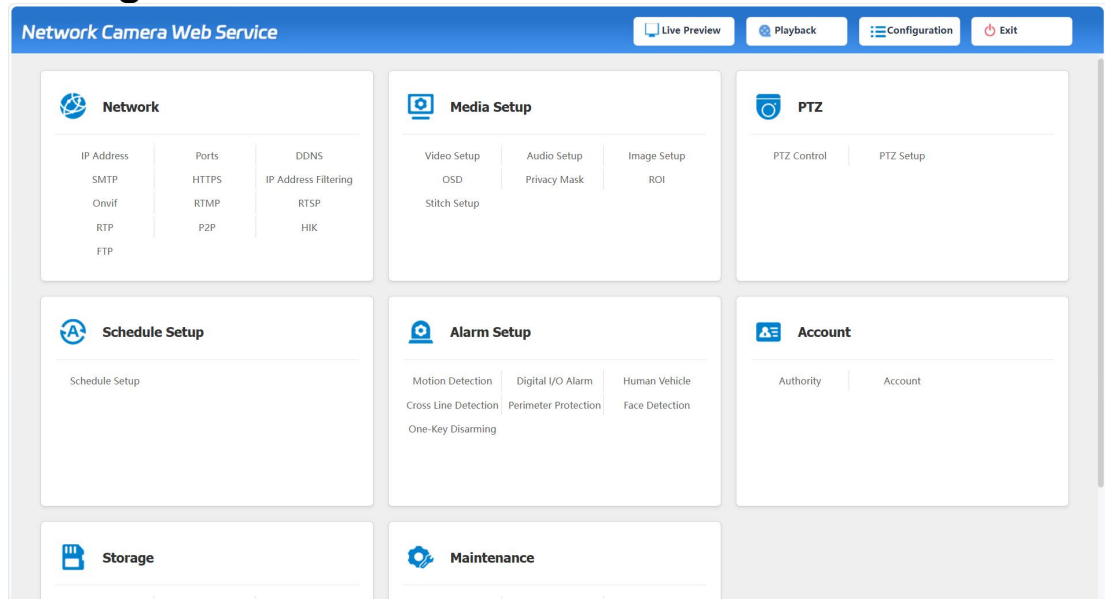

1) To setup the camera **Time & Date**

➤ **Configurations > Maintenance > Date&Time**

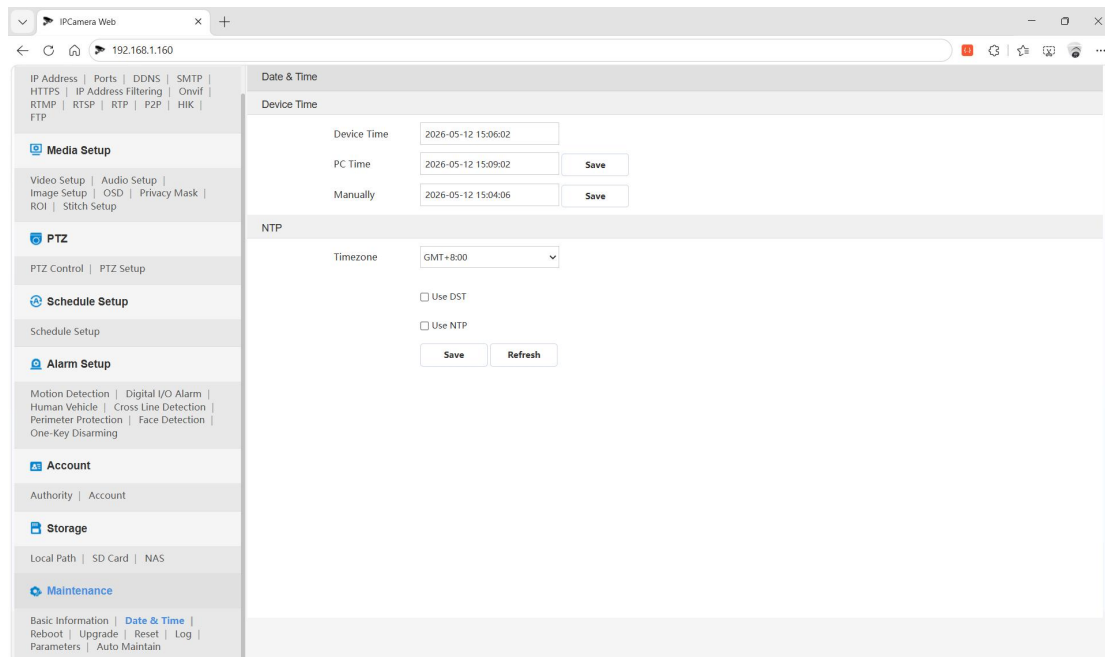

There are two time update modes available - **Manual (Sync with PC)** and **NTP**.

**DST** (daylight-saving time) is available for time offset adjust automatically.

**NTP** (network time protocol) is used for scheduled getting correct date and time from Internet automatically.

If the camera is connected to the NVR system, camera time will be synchronized automatically.

2) To name the camera title

➤ **Configurations > Media Setup > OSD**

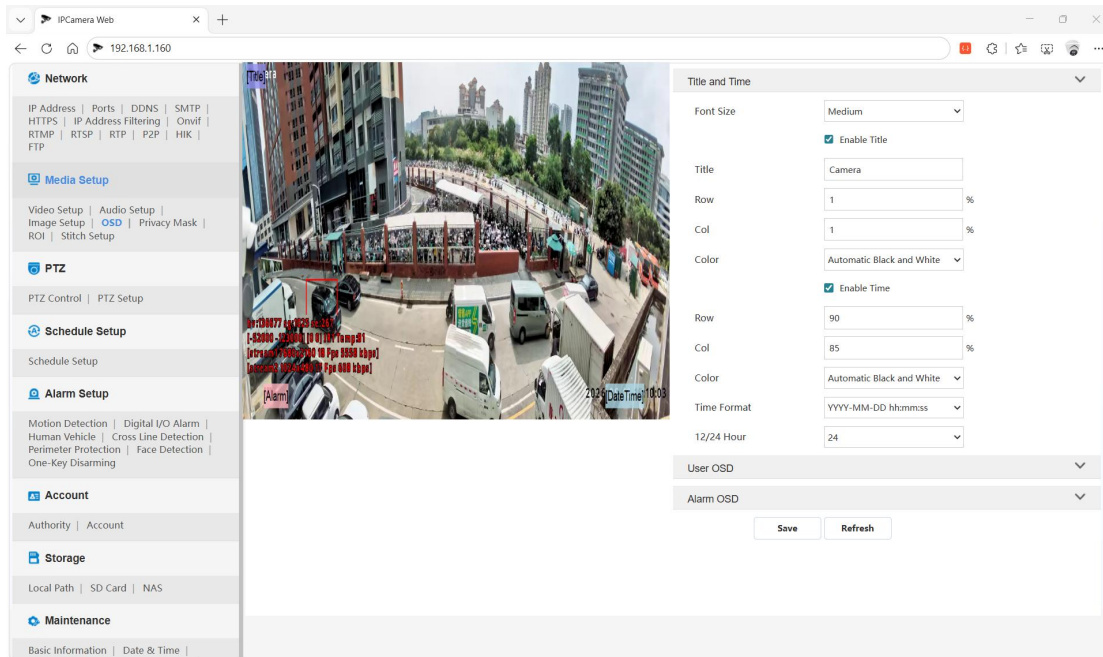

Modify the title and time format as you need, drag the items to adjust the showing position if needed, click **Save**.

Note: the **Alarm OSD** will show at the bottom-left when events happen

**H** - human detected,    **V** - vehicle detected  
**F** - face detected,    **S** - alarm input triggered

### 3) Image Setup

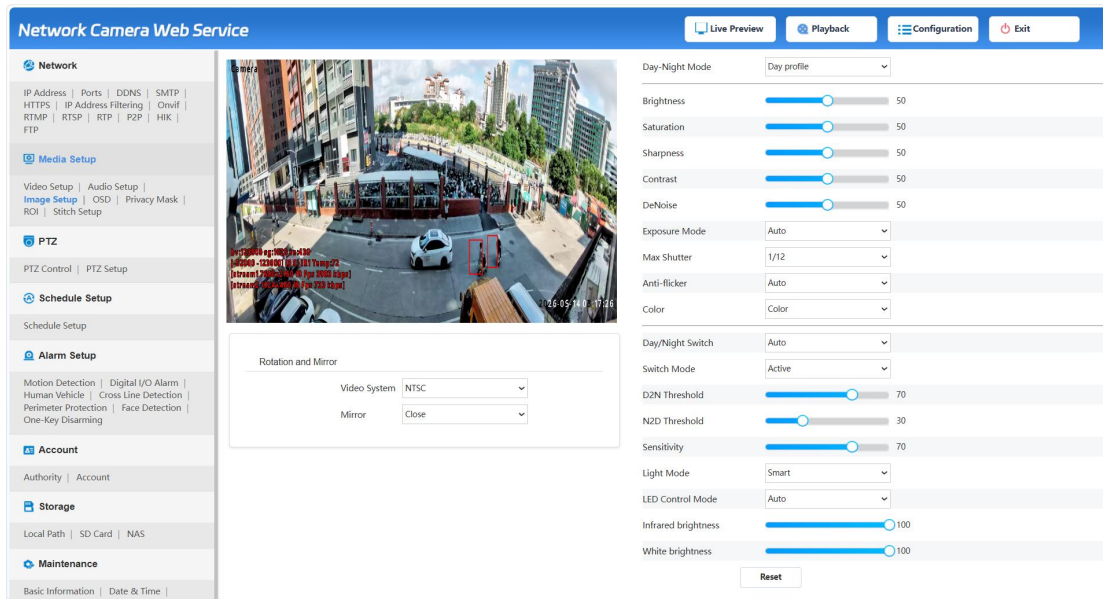

#### Video System:

**NTSC/PAL** (NTSC for 60HZ , PAL for 50HZ alternating current power system)

**Day/Night profile:** switch to change the day or night image parameters

**Max Shutter:** adjust the long shutter speed (improve low-light snapshot ghostly)

**Anti-flicker:** auto by default ,when image flicker or scrolling, adjust 50/60Hz to fix

**Day/Night Switch:** auto/day/night

#### Switch Mode:

**Active** - software control IR board

**Passive** - IR sensor board control mainboard by CDS-in

**Scheduled** - switch day/night by timing

**Sensitivity:** adjust the day night switch delay time

#### Light Mode:

**Smart** - when human/vehicle get in view, image change white-black to color, close IR and open white light

**Infrared** - only IR mode

**White Light** - only white light mode

#### 4) SD memory card recording(optional)

##### ➤ **Configurations > Storage > SD Card (with Micro-SD slot only)**

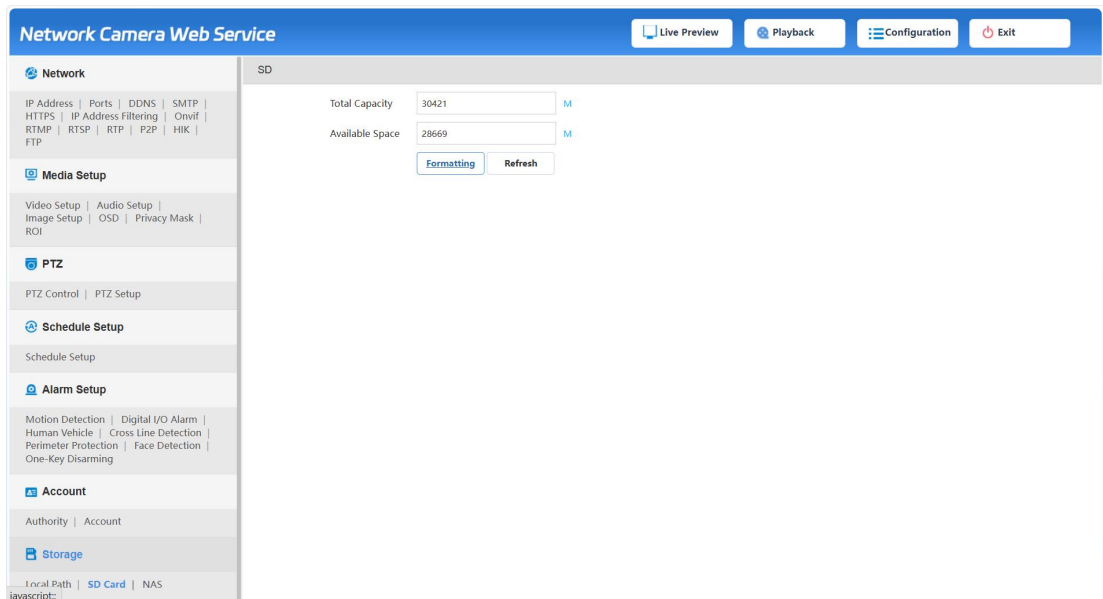

It is suggested to install the memory card (Class10: 32GB - 512GB) for local storage if you need playback from camera.

Once memory card inserted, camera will format it , show capacity and start 24 hours recording with a red status icon at the top-right corner of the video automatically.

#### 5) Playback and Download video (optional)

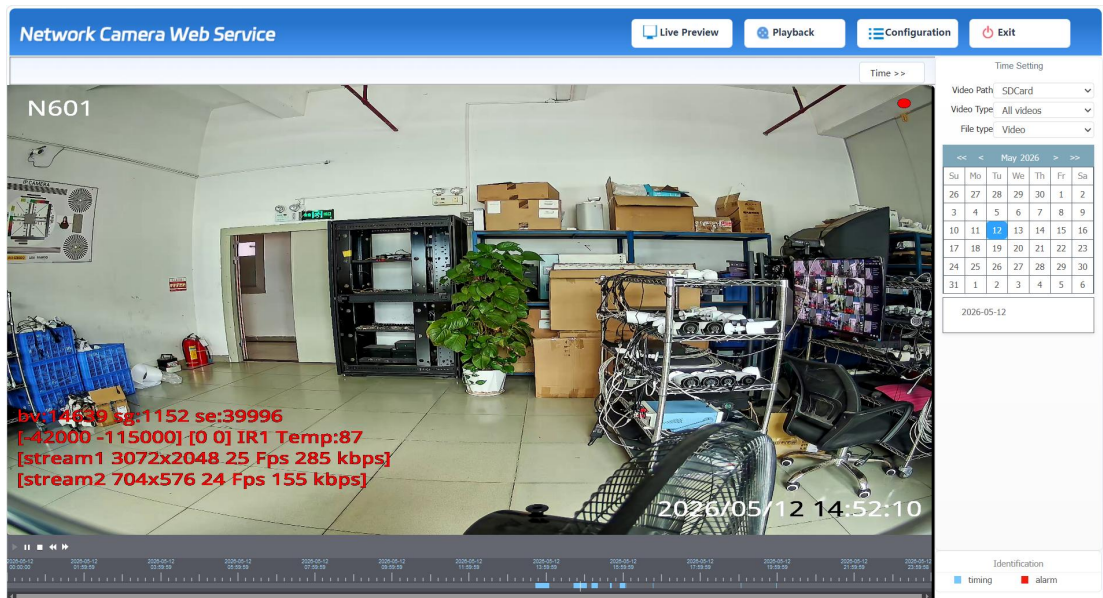

**Playback:** click **Playback** button, select desired date from right calender, double-click the time bar (red is event recording, blue is normal record).

**Backup:** scrolling mouse wheel to zoom in on time bar, drag to select the video clip, right-click and click the **Download** menu.

**File path:** C:\Users\<<your name>\AppData\Local\NsdPlayerV4\record (default path)

Local Path

Snapshot Storage Path	<input type="text" value="C:\Users\30781\AppData\Local\NsdPlayerV4\capture"/>	<input type="button" value="Browsing"/>
Record Storage Path	<input type="text" value="C:\Users\30781\AppData\Local\NsdPlayerV4\record"/>	<input type="button" value="Browsing"/>
<input type="button" value="Save"/>		<input type="button" value="Refresh"/>

6) Smart phone p2p remote access by scanning QR code

➤ **Configurations > Network > P2P (Enable manually)**

IP Address | Ports | DDNS | SMTP | HTTPS | IP Address Filtering | Onvif | RTMP | RTSP | RTP | **P2P** | HIK | FTP

Media Setup

Video Setup | Audio Setup | Image Setup | OSD | Privacy Mask | ROI | Fisheye Mask

PTZ

PTZ Control | PTZ Setup | Special Preset

Schedule Setup

Schedule Setup

Mobile Phone Setup

Enable Mobile Monitoring

UID: 1-1072



Scan The QR Code To Add Device

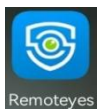

1. Install app "remoteyes" from Google Play Store or Apple Store
2. Scan camera p2p QR code to add device

7) To setup Smart **Human Detection** and **Vehicle Detection** (default enabled)

➤ **Configurations > Alarm Setup > Human Vehicle Detection**

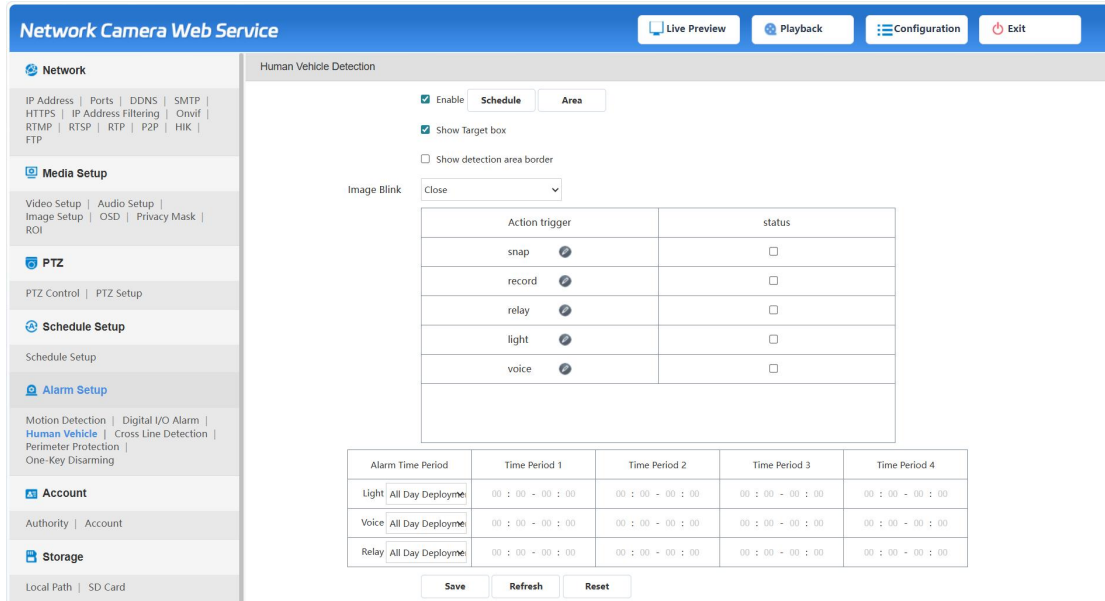

**Detection target:** human / vehicle / bicycle

**Detection Area:** default full-screen / user-defined drawing

**Show target box:** display a rectangular border to surround the target

**Threshold:** filter small target

**Action trigger:**

1. snap -- trigger snapshot when event happen;
2. record- trigger snapshot when event happen;
3. relay -- trigger alarm out relay and red&blue flashing;
4. light -- trigger white lights flashing as warning;
5. voice -- trigger loud speaker voice or tones playing

8) \* To setup Smart **Line Crossing Detection**

➤ **Configurations > Alarm Setup > Cross Line Detection**

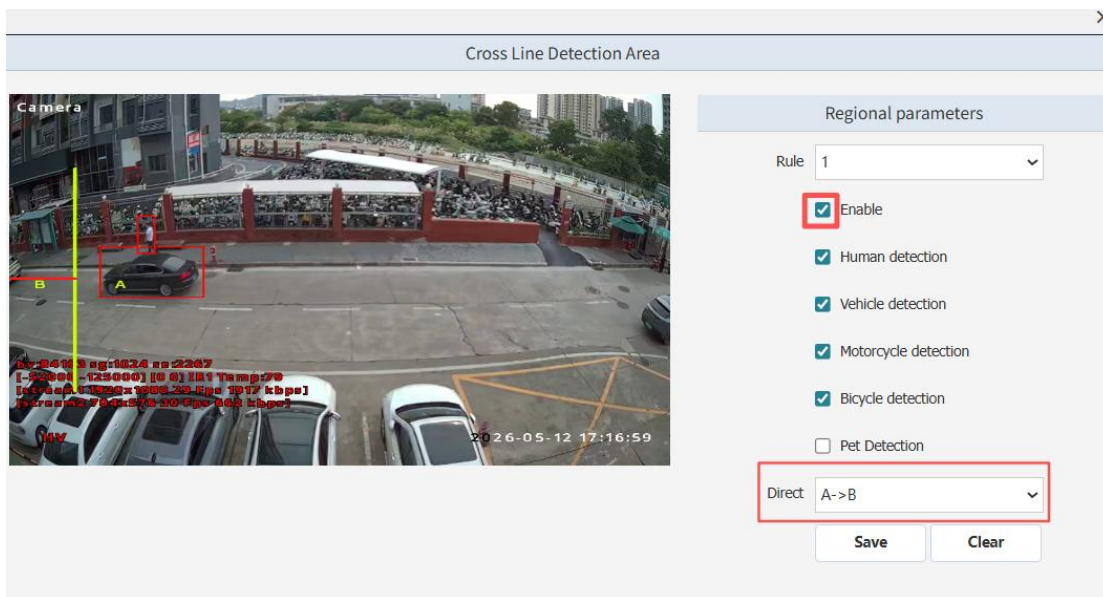
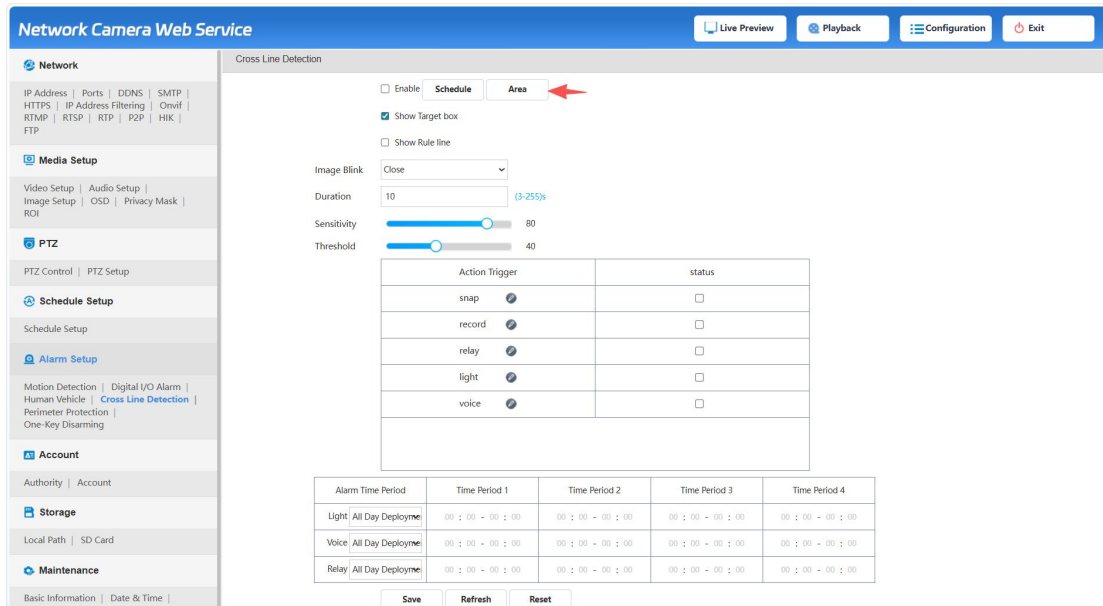

Setup step: 1. check the **main enable** checkbox;

2. click "**Area**", select a rule and check the **sub enable** checkbox;

3. drawing alarm rule line;

4. select detection target and moving direction (A->B, B->A, A<->B);

5. select the trigger actions when desired.

9) \* To setup Smart **Perimeter protection**

➤ **Configurations > Alarm Setup > Perimeter protection**

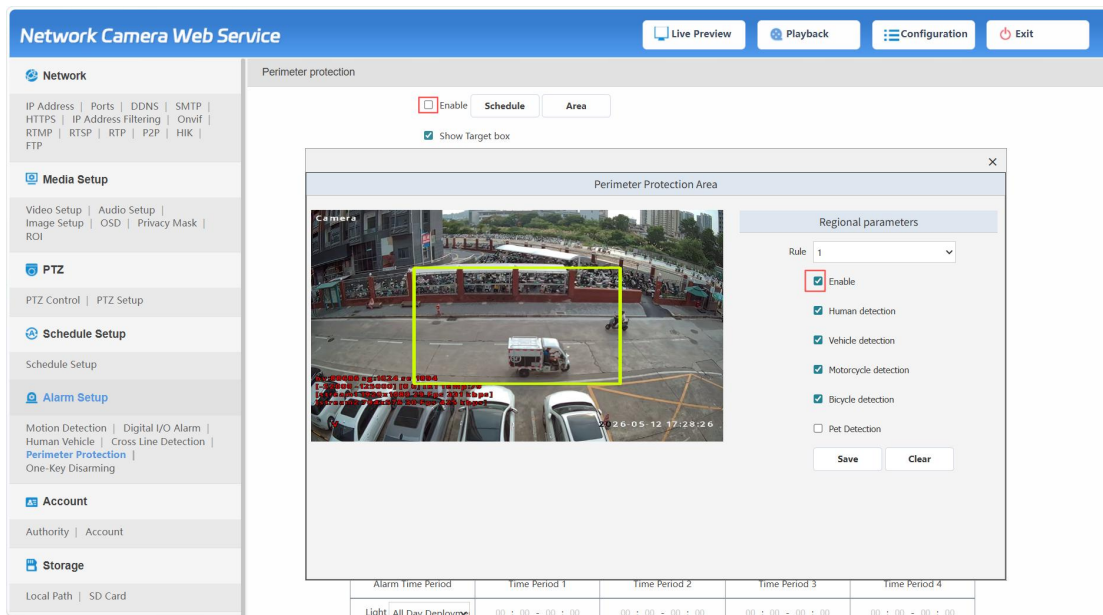

- Setup step: 1. check the **main enable** checkbox;
2. click "**Area**", select a rule and check the **sub enable** checkbox;
  3. drawing alarm rule box;
  4. select detection target and save;
  5. select the trigger actions when desired.

## 10) \* To setup Smart **Face Detection**

### ➤ **Configurations > Alarm Setup > Face Detection**

The screenshot shows the 'Face detection' configuration page in the 'Network Camera Web Service'. The left sidebar contains navigation menus for Network, Media Setup, PTZ, Schedule Setup, Alarm Setup, Account, Storage, and Maintenance. The main content area is titled 'Face detection' and includes the following settings:

- Enable** (highlighted with a red box)
- Schedule** and **Area** tabs
- Show Face Score
- Show Target box
- Show detection area border
- Image Blink: Close
- Snap Mode: Effect Priority
- Preferred face count: 1 (1-3)
- Minimum Pixel: 60** (highlighted with a red box, range 12-1000px)
- Maximum Pixel: 800 (12-1000px)
- Duration: 1 (1-255s)
- Sensitivity: 80
- Thresholds: 70
- Image Upload: Face+Original

Action Trigger	Status
snap	<input type="checkbox"/>
record	<input type="checkbox"/>
relay	<input type="checkbox"/>
light	<input type="checkbox"/>
voice	<input type="checkbox"/>

Setup step: 1. check the **Enable** checkbox;

2. click "**Area**" (default full-screen)

3. drawing detect area when needed;

4. select the trigger actions when desired;

5. click "**save**".

### **NOTE:**

To get a clear face snapshot, adjust the minimum face pixel to larger (60+)

To get a long distance face detection event, adjust the minimum face pixel to small (40- )

## Working with smart Phone (Android & iPhone)

Visit the **Apple Store** or the **Google Play Store** to download the **remoteyes** app for iOS or Android devices. After installation, tap the icon to launch the **remoteyes** app. For the first time use, please create a new account.

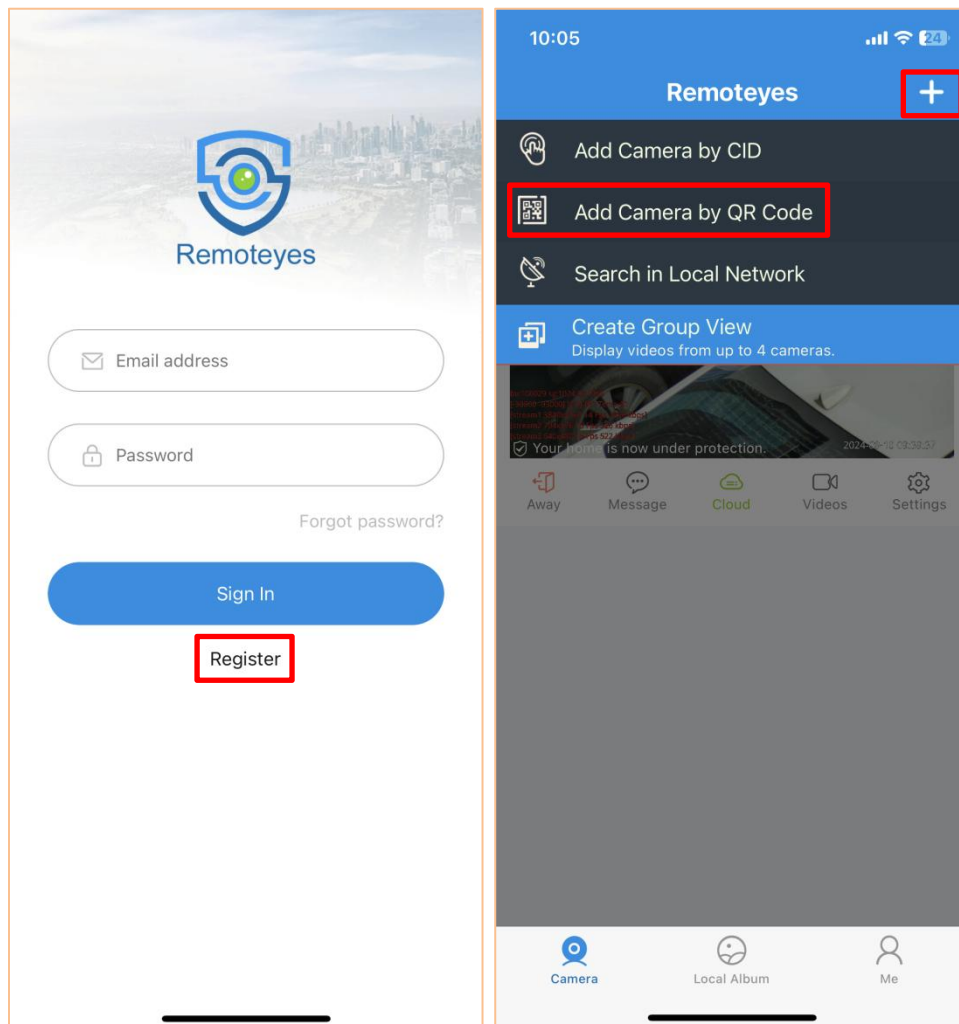





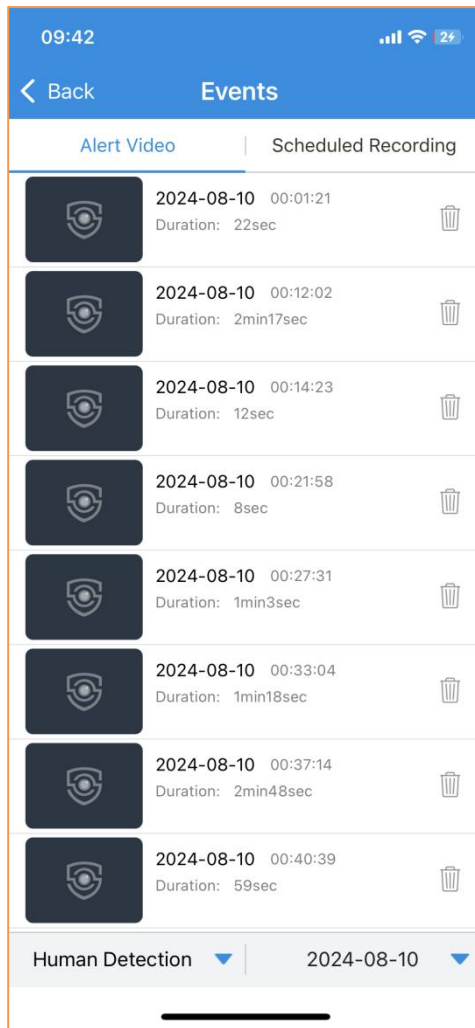
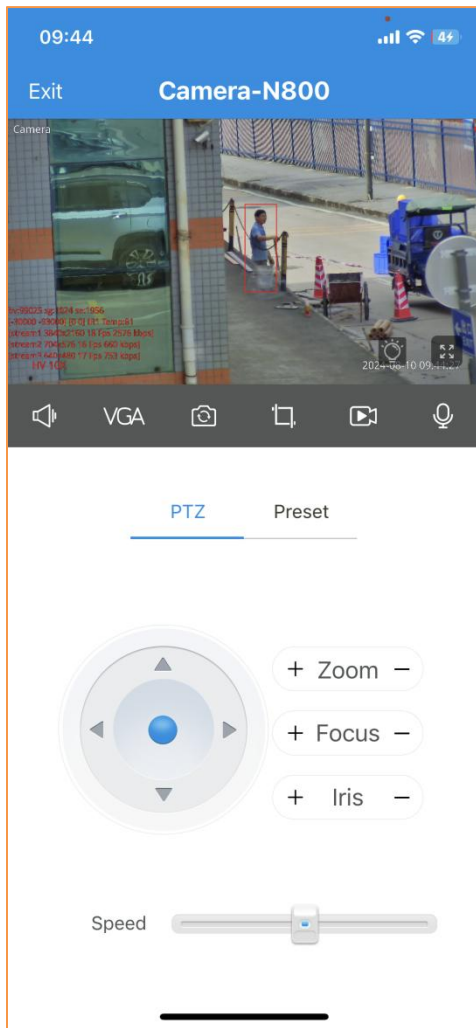





### General use steps

1. For new users, please tap **CREATE NEW ACCOUNT** to register an account
2. Tap "+" select "**Add Camera by QR Code**"
3. Get into the camera QR code web page (**Configurations > Services Security > P2P mobile view (Enable manually)**)
4. Put the IP camera QR code in the app effective scan area to finish adding
5. Tap the camera list to start live video



## Function description

Icon	Function description
 Away	Away / Home : push notifications or not
 Message	Additional Cloud paid service

 Cloud	Additional Cloud paid service
 Videos	Video playback
 Settings	Go to camera settings
	Switch HD or SD live resolution
	Rotate camera image direction
	Take snapshot
	Record video clip
	Start two-way audio intercom
	Change night mode (IR / Color / Auto)

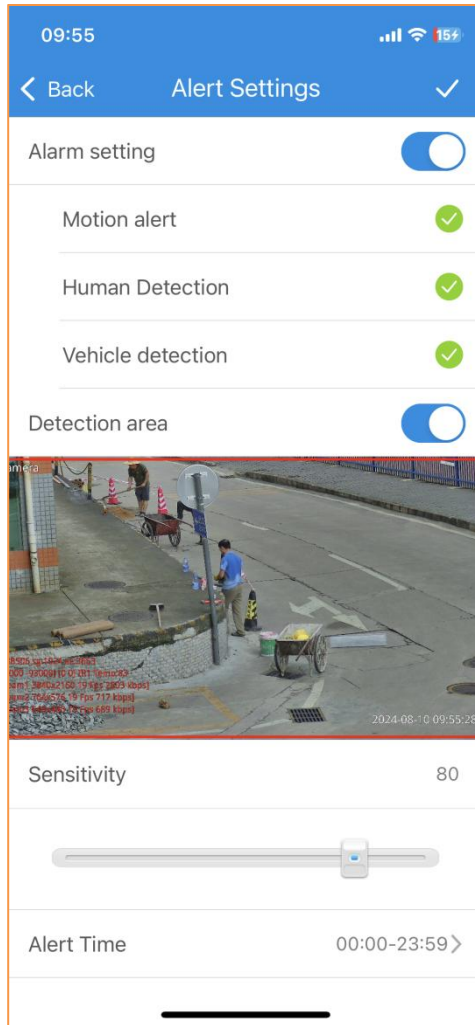
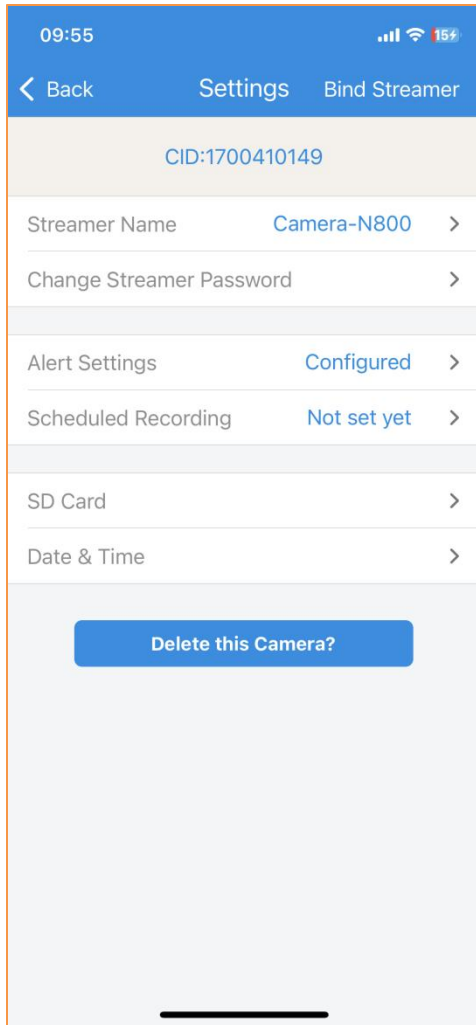

**Note:**

if you cannot connect the camera, please check your Internet connection and verify the IP address, gateway, and DNS setting in the camera.

The Cloud login status should be **online**, which means the camera has registered to the cloud server.

You may also want to connect your phone to WiFi for better performance.

## Working with NVR

The IP camera supports standard ONVIF protocol and it can be added to third-party video recorder.

Some of the models support both H.264 and H.265 encode mode. The H.265 encode cameras can compress the video data to a very low bit rates which allows more video data storage than normal H.264 camera.

Before pairing cameras to the NVR, make sure the NVR and cameras have valid and matching IP address scheme.

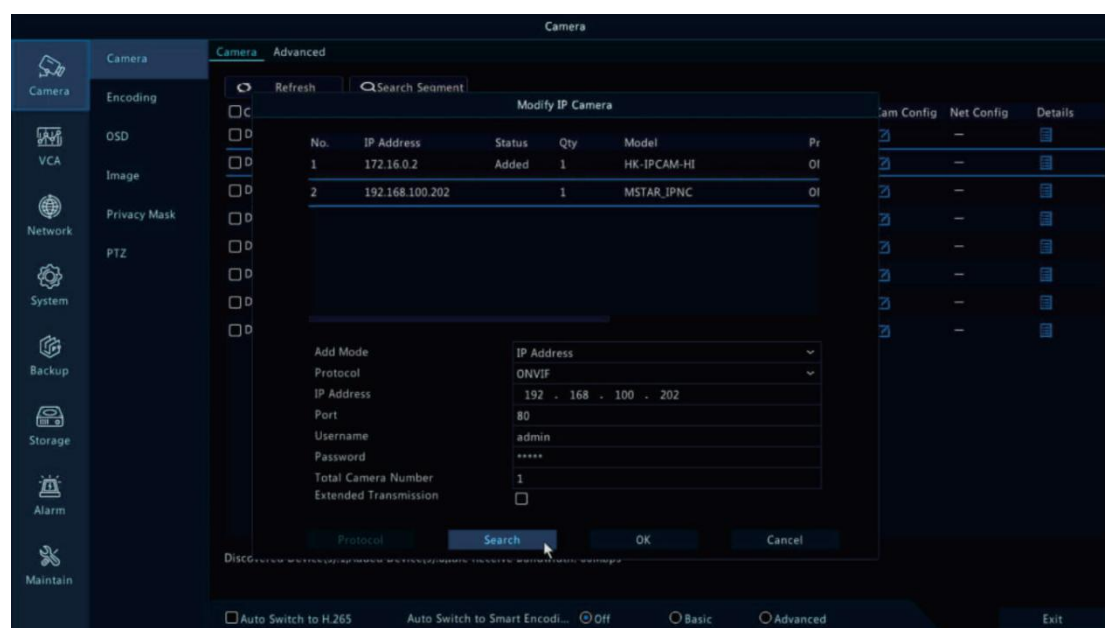

**Note:** Some of the PoE NVR supports **Plug & play**, which allows you to get video without manually search and add. if **Plug & play** feature is not available or not compatible, please follow the NVR manual steps and select **ONVIF** protocol as the pairing protocol. (*Camera default password: 123456*)

If the POE NVR can not discover the connected camera or can not display the camera video , please check it's internal POE interface IP configuration and make sure all connected cameras and NVR POE interface are in the same subnet schema.

For more help please contact the both NVR and IP camera suppliers for technical assistance.

## Frequently Asked Questions

1. Why can't I open the default IP address 192.168.0.123 via web browser?

The camera is working at DHCP mode by default, it will obtain the IP settings from router automatically . Please install the IP search tool to find the camera's IP address. Camera IP address will be 192.168.0.123 if no router in the LAN.

2. How to reset the password?

- 1) install the Setting tool to search the camera IP and click **Batch Reset** button.
- 2) if the camera with a built-in hardware reset button and easy touched, just keep pressing it around 10 second.

3. How to upgrade the IP camera?

- 1) ask the supplier for the suitable firmware,
- 2) use the web browser, search tool or NVR to upgrade the camera,

4. How to fetch the RTSP video stream and http snapshot?

- 1) VLC test Main Stream: rtsp://admin:123456@IP:554/media/live/1/1
- 2) VLC test Sub Stream: rtsp://admin:123456@ IP:554/media/live/1/2
- 3) Low resolution snapshot: http://IP/cgi/special.cgi?act=snapshot&stream=1
- 4) HD snapshot : http://IP/cgi/special.cgi?act=snapshot&stream=0  
*(some models support)*

5. How to Add IP camera to NVR?

- 1) Make sure the NVR and IP camera are the same IP subnet.(eg. NVR:192.168.1.x, and IP camera:192.168.1.y)
- 2) Try changing the protocol to ONVIF

6. How to make the NVR record in motion detection mode?

- 1) change the NVR record mode to Motion Detection mode
- 2) check the NVR screen MD icon and try playback  
*Please refer to your NVR manual for NVR motion record option, camera also should enable motion detection.*

7. Where can i control the motorized auto focus lens zoom?

- 1) Using the camera's web interface
- 2) Control zoom by mobile app
- 3) Go to the setting tool configuration tab and select PTZ tab window
- 4) Find the PTZ menu in your NVR to control lens zoom

8. Which kinds of third-party security software can be compatible with?

Milestone, Avigilon, Pelco VxToolbox, Blue Iris, iSpy, Synology, Digifort ...